

COOPER

Bussmann®

Productivity Through Protection™

Circuit Protection Solutions

Medium Voltage DIN Fuses





WORLDWIDE CIRCUIT PROTECTION SOLUTIONS

Cooper Bussmann is one of the world's leading suppliers of fuse-links and fusible protection systems. Provider of the world's first truly global product line, each product is backed by an efficient worldwide distribution network service and unrivalled technical support. Cooper Bussmann® circuit protection solutions comply with major international standards: BS, IEC, DIN and UL.

Cooper Bussmann® Medium Voltage fuses have absorbed and embodied the expertise and experience of thirteen of the most prestigious manufacturers and are able to offer an unbeatable range of products in terms of technical excellence, performance and quality.

Cooper Bussmann offer a wider range of Medium Voltage fuses than any other manufacturers and types are available to meet most service applications. With over 50 years experience in design and manufacture, Cooper Bussmann have supplied fuselinks to more than 90 countries worldwide.

Cooper Bussmann® Medium Voltage fuse-links are extremely effective in preventing damage to a system in the event of a fault, due to considerable limitation of let-through current in DIN and British Standard designs to the latest IEC requirements.

Cooper Bussmann are pioneers in the development of Full Range Medium Voltage fuse-links and is consequently the market leader in this field offering genuine full range characteristics.

Cooper Bussmann's team of specialist engineers play a leading role in international standardisation of Medium Voltage fuses, offering a comprehensive service of advice, on selection and applications.

With a continual commitment to meet our customers' needs, with innovative, high quality products with ISO 9002 'approved systems', Cooper Bussmann is the suppliers' choice for Medium Voltage Circuit Protection Solutions.

Medium Voltage DIN Fuses

Table of Contents

	Page
Introduction	2 - 4
Features & Benefits	5
3.6kV	6
7.2kV	7
12kV	8
17.5kV	9
24kV	10
36kV	11
Fuse-Links Bases	12
Applications	13 - 14
Cross-Reference	15
Striker Force Diagrams	16
Part Referencing System	17

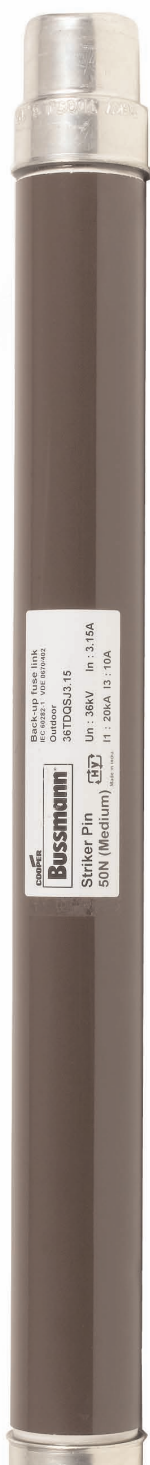

Introduction

Offering unparalleled short-circuit interruption capabilities, medium voltage current-limiting fuse-links are the principle protection device used by electrical utilities and switchgear manufacturers throughout the world. Safe, reliable, environmentally friendly and cost effective, medium voltage fuse-links are the protection device of choice for distribution transformer circuits due to their speed of operation and **current limiting** ability in the event of a short-circuit fault.

The diagram below shows the operation of a fuse-link interrupting a short circuit fault, achieving a current zero well within the first half-cycle of a fault. Energy let-through into the site of a fault maybe typically only **1/500th** that any other type of switching device.

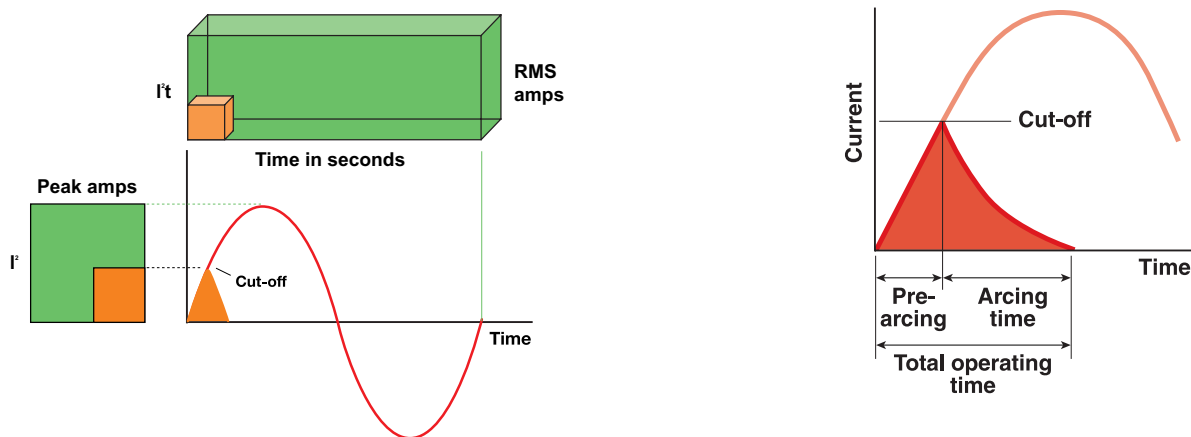

The speed of operation reduces the effect of short circuit currents, dramatically limiting the energy delivered to the faulted circuit - preventing the catastrophic results of high faults and disturbing voltage arcs. The fuse-link operation significantly limits the arc-flash hazard at the fault location. Improved power supply quality also results from the use of fuse-links. High fault currents are interrupted in a few milliseconds, minimising voltage dips in system supply voltage.

Glossary for medium voltage fuse-links

The following is a brief introduction to medium voltage fuse-link technology. Some of the terms are also used in other areas of fuse technology.

- **Current-rating/Rated current, I_n** - The rated current of the fuse-link, given in amps, in free air.
- **De-rating** - A reference to the fact that all medium voltage fuse-links must be de-rated once they are placed in a confined space, for example when mounted in switchgear. The fuse-link must be de-rated to take into account the effect of heating on element resistance. Typically a fuse-link is de-rated by between 5-20% depending on application.
- **Test duty, TD** - A term used to refer to a specific type test within IEC. Test duty one (**TD1**), short-circuit test, Test duty two (**TD2**), maximum arc energy test and Test duty three (**TD3**), low overcurrent test.
- **Minimum breaking capacity current, MBC, I_3** - The minimum current the fuse-link can interrupt safely, without assistance from switchgear associated all phase tripping.
- **Minimum fusing current (MFC)** - The minimum current which will cause the fuse-link elements to **start to melt**.
- **I^2T** - The minimum value of pre-arcing and maximum value of total clearing energy a fuse-link will allow to pass through it during short circuit operation, expressed as an amount of current (I^2), multiplied by time in seconds.
- **Watts loss** - The power dissipation of the fuse-link at a stated value of load current.
- **Breaking capacity, I_1** - The maximum short circuit current the fuse-link has been tested to in accordance with test duty one (TD1), expressed in kA.
- **Resistance** - The resistance of the fuse-link in free air at (20°C), measured in mΩ.

Medium Voltage Fuse Technology

The main standard covering medium voltage fuse-links is IEC 60282-1, 2005. IEC defines **medium voltage** as from **1kV to 72.5kV**.

Current-limiting medium voltage fuse-links (MV fuses), split into three internationally recognised types: **Back-Up** (or sometimes called partial range), fuse-links, which will interrupt any current from their rated breaking capacity down to a minimum breaking current, specified by the manufacturer. **General Purpose** MV fuses will interrupt all currents that will melt the elements within one hour. **Full Range** MV fuses can interrupt any current below the rated breaking capacity that melts the fuse elements satisfactorily.

The diagram below illustrates the three performance criteria in terms of their minimum breaking current I_3 .

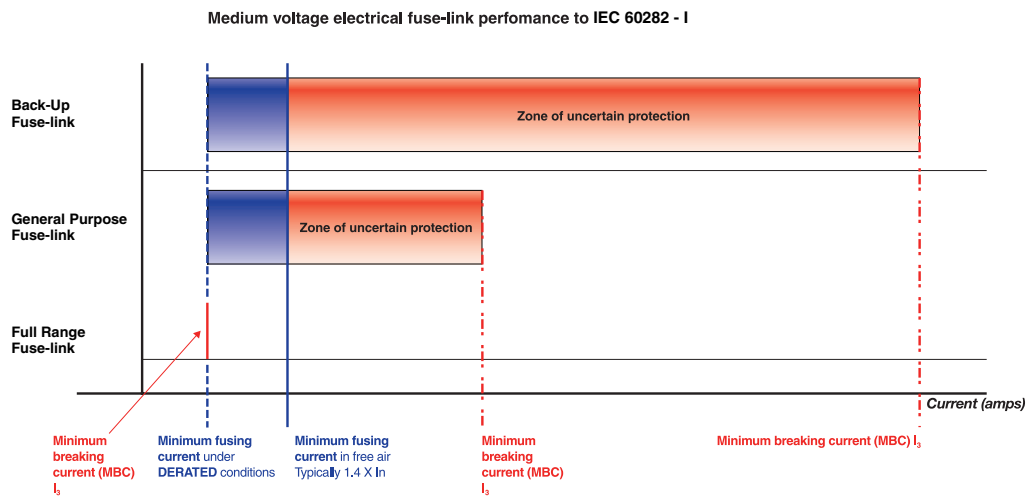

Current-limiting MV fuses are similar in construction to LV cartridge types. Fuse elements do need to be much longer however to safely interrupt a high voltage short-circuit. This is achieved by winding the elements round an internal core or holder, often called a star-core or spider; using this technique a one metre length element can be accommodated in a 250 mm length body. The elements are surrounded by a pure, highly compacted granular quartz filler.

Like a low voltage fuse-link, an MV fuse has a ceramic body. Most current-limiting MV fuses are also fitted with a striker mechanism. This is used to operate the trip bar or mechanism in a fuse-switch combination, fuse-switch or ring main unit (RMU) to achieve low overload fault interruption and three phase disconnection.

Typically striker mechanisms are driven by a spring mechanism, triggered by a thin striker wire or striker coil running the length of the fuse, connected in parallel to the fuse elements. The striker coil is of much higher resistance than the fuse elements, so a current only flows through the striker coil when the fuse elements melt. The current heats up the striker coil and this in turn melts the wire retaining the spring, releasing it and pushing out the striker.

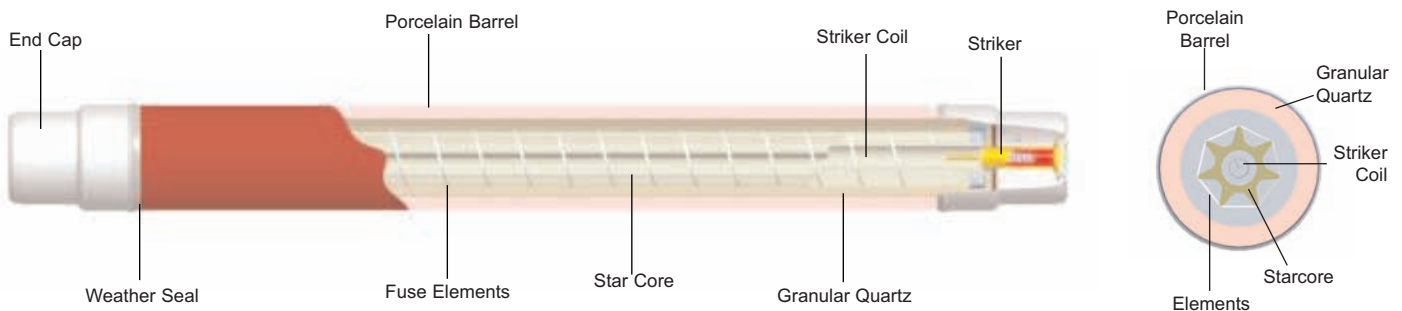

Medium Voltage Fuse Technology

Thermal effects of low overload faults

During overload faults lasting a long time, it is possible for medium voltage elements to get very hot prior to actually melting. Given that silver has a melting temperature of 960°C, for fuses with no temperature limitation, this can result in a fuse barrel temperature of over 400°C and 180°C at the insulating surface surrounding the fuse. To prevent deterioration of the insulation and to the fuse itself, all medium voltage fuse-links should incorporate some form of technology to limit the thermal stress - heating, that is possible under prolonged low overload faults, often referred to as temperature limiting technology.

Since the launch of its first MV DIN fuses almost half a century ago, Cooper Bussmann has employed **M-effect technology** to achieve **temperature limitation** throughout their medium voltage fuse range. A small mass of special low melting point alloy is added to each fuse element, this has the effect of drastically reducing the temperature of the MV fuse during operation. The larger cross section of the fuse elements made possible by use of this feature ensures cooler running and lower power dissipation under normal service conditions than comparable temperature limitation technology.

Other manufacturers employ a temperature-limiting (or thermal) striker to overcome their overheating problems. In general with this approach the maximum temperatures reached by the fuse and its surrounding insulation are not as low as with the use of M-effect. Such a solution is no more effective than use of M-effect on the fuse elements and moreover does not bring the additional advantages of lower watts loss cooler running and greater withstand against transient surge currents.

When a Cooper Bussmann® fuse operates under low overload fault conditions the maximum temperature rise of the fuse-link is such that the temperature of the surrounding synthetic insulation remains below the temperature limits for all insulated fuse switchgear. The fuse barrel therefore remains intact and the fuse carrier and its contacts remain unimpaired.

Typically a Cooper Bussmann® MV fuses of a given rating may run 10-30°C cooler than comparable fuse-links which do not employ M-effect. This advantage is particularly useful when the MV fuse-link is used in totally enclosed all insulated switchgear, such as cast resin fuse-switches or compact SF6 insulated Ring Main Units (RMUs), or GIS MV switchgear, since less derating is required and hence a smaller rating of MV fuse-link will do the same job as a higher rated MV fuse-link from another manufacturer.

The Cooper Bussmann® T Range

The Cooper Bussmann® T range of medium voltage current-limiting fuse-links to dimensional standard DIN 43625 are one of the most advanced designs of medium voltage fuse-links available anywhere in the world today. Developed by Cooper Bussmann, they comply with the very latest issues of IEC 60282-1, are lead and cadmium free (complying with RoHS and WEE directives) and have been designed to meet current and future electrical utility specifications worldwide.

The T range offers **time current characteristics** that are **optimised** to improve discrimination with upstream devices, giving fast clearance of earth faults in secondary terminal zones. The fuses utilise Cooper Bussmann M effect technology, ensuring low power consumption during operation, while at the same time providing **temperature limitation in the event of an overload fault**.

The fuses are suitable for both indoor and outdoor applications and are fitted with a spring striker. This gives either an output force of 80N with a travel of 30mm in the case of fuse-links with part number sequence "**E**", or in the case of part number referring to "**S**", a spring striker with an output force of 50N and a maximum travel of 26mm. This follows Cooper Bussmann easy to use intelligent part numbering system (see page 17)

Features & Benefits

Certification. The Cooper Bussmann® MV DIN range of fuses has been fully tested and certified. Interrupting performance has been certified at the world class independent test laboratories of KEMA. All other performances requirements such as temperature-rise, time-current characteristics, weather sealing etc. have been thoroughly tested to ASTA approval procedures.

All Cooper Bussmann® medium voltage DIN fuses exhibit **cool running and low power dissipation** during normal operation in service. The use of **M-effect (as already explained), drastically reduces the temperature of the fuse-link during operation.** The larger cross section of the fuse-link elements made possible by using M-effect ensures cooler running and low power dissipation under normal service conditions. **This ensures maximum levels of network efficiency by reducing unnecessary power loss** and minimizing switchgear wear and tear due to the fact the fuse-link is running much cooler during its service life.

Cool operation. When Cooper Bussmann® MV fuse-links operate under low fault conditions, the maximum temperature rise of the fuse-link is well within the temperature limits for all switchgear due to the use of M-effect, ensuring fuse carrier contacts remain unimpaired, thereby **increasing the life cycle of the substation** and so **reducing capital and maintenance costs.**

Silver elements. All Cooper Bussmann® Back-Up MV fuses use 99.8% pure silver in their elements, ensuring high conductivity and **low power (revenue) loss, maximising network efficiency.**

Reduced nuisance operation due to surge currents. The use of M-effect allows a larger element cross section for a given current rating, **improving withstand capability** against transient overcurrents due to transformer magnetizing inrush current, reducing mal operation. **This improves system reliability reducing maintenance costs.**

Low arc voltages during short-circuit operation. Cooper Bussmann® MV fuse-links are designed to produce low levels of arc voltage, allowing fuses **to be used down to half their rated voltage**, so during short-circuit operation, the switchgear and cables are not unduly stressed by being exposed to high arc voltages, thereby **prolonging the life of the switchgear and improving asset utilization.**

Additionally **stock holdings and part numbers can be reduced**, as a 24kV Cooper Bussmann MV DIN fuse can be used on a 12kV system. Utilities that run a mixed voltage network (say 24, 15.5, 13.8 12 and 10 kV) can **standardise on one type of switchgear** with one type of fuse-link, **reducing costs** and **removing the need for an additional fuse extension and inventory.**

Construction. All electrical connections within the Cooper Bussmann® MV fuse-link are made by welded or brazed joints. This firstly ensures a **very mechanically robust fuse-link** and secondly, greatly **reduces the risk of poor intermittent internal contacts, improving substation reliability.**

X-Ray. All Cooper Bussmann® MV fuses are X-rayed during production. Element alignment, M-effect position etc are all checked by trained operators, this process ensures defects that would normally not be detected by purely visual or electrical based quality systems are detected during manufacture.

Element design. Unlike many other medium voltage fuse-link manufacturers, Cooper Bussmann® medium voltage fuse element employ a “neck” or “notch” design principle as opposed to a perforated element design principle, see diagram below.



This element design insures that even the smallest degree of accidental element damage is easily detected during manufacturing test measurements and thus avoids the possibility of such imperfect fuses being put into service. This is far more difficult to achieve with perforated element designs.

Lead and Cadmium Free. All Cooper Bussmann® T Ranges fuse-links are lead and cadmium free and comply fully with the latest WEE and RoHS directives.

Recycling scheme. Cooper Bussmann operates a recycling scheme for all medium voltage fuse-links.

3.6 kV - A & W Range Fuse-Links

3.6 kV, Current Limiting Back-Up Fuse-Links, 6.3A to 200A

Specifications

Description: A range of medium voltage DIN Fuses, complete with striker, suitable for transformer protection. The fuses can be used even when there is no secondary LV protection, provided they are used with fuse switches fitted with instantaneous striker tripping.



Ratings:

Volts: 3.6kV

Amps: 6.3A - 200A

Breaking Capacity: 40kA - 50kA

Agency Information:

Comply with DIN Dimensional standard DIN 43625, VDE 0670 part 4 and with IEC 60282-1 (2005)

Suitable for indoor use.

Dimensions (mm):

Fuse Reference	A	C	D	Weight (Kg)
ADOSJ	192	54	51	1.1
WDOSJ	192	54	51	1.1
WFOSJ	192	76	76	2.1

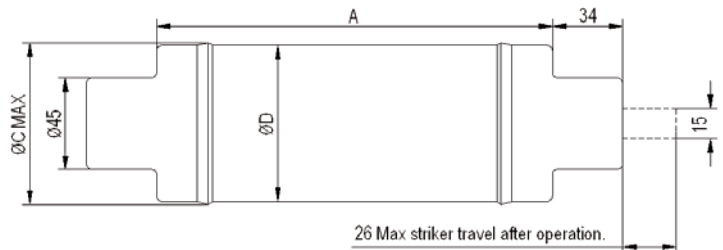

Table of ratings:

Part Number	Current Rating I_n (A)	Breaking Capacity I_1 (kA)	Minimum Breaking Capacity I_3 (A)	Cold Resistance & Watts Loss in Free Air		Joule Integral (I^2t)		Length mm	Diameter mm	Weight kg
				mΩ	W	Minimum Pre-Arcing	Maximum Operating			
3.6ADOSJ6.3	6.3	40	13	158	9	4.5×10^1	1.9×10^2	192	51	1.1
3.6ADOSJ10	10	40	31	79.2	11	2.3×10^2	9.7×10^2	192	51	1.1
3.6ADOSJ16	16	40	49	50.8	18	5.5×10^2	2.4×10^3	192	51	1.1
3.6ADOSJ20	20	40	49	38.1	21	9.8×10^2	4.2×10^3	192	51	1.1
3.6ADOSJ25	25	40	106	28.9	25	1.3×10^2	1.2×10^3	192	51	1.1
3.6ADOSJ31.5	31.5	40	106	19.2	26	2.9×10^2	2.7×10^3	192	51	1.1
3.6ADOSJ40	40	40	106	11.6	26	8.0×10^2	7.5×10^3	192	51	1.1
3.6WDOSJ50	50	50	180	5.36	20	1.8×10^3	2.4×10^4	192	51	1.1
3.6WDOSJ63	63	50	225	3.68	21	3.8×10^3	4.5×10^4	192	51	1.1
3.6WDOSJ80	80	50	288	2.88	27	6.3×10^3	8.0×10^4	192	51	1.1
3.6WDOSJ100	100	50	360	2.16	31	9.8×10^3	1.1×10^5	192	51	1.1
3.6WDOSJ125	125	50	450	1.73	39	1.5×10^4	2.2×10^5	192	51	1.1
3.6WFOSJ160	160	50	600	1.28	47	3.1×10^4	6.2×10^5	192	76	2.1
3.6WFOSJ200	200	50	600	0.938	52	5.7×10^4	1.1×10^6	192	76	2.1

7.2 kV - T Range Fuse-Links

7.2 kV, Current Limiting Back-Up Fuse-Links, 6.3A to 160A

Specifications

Description: A range of medium voltage DIN Fuses, complete with striker, suitable for transformer protection. The fuses can be used even when there is no secondary LV protection, provided they are used with fuse switches fitted with instantaneous striker tripping.

Ratings:

Volts: 3.0kV - 7.2kV
 Amps: 6.3A - 160A
 Breaking Capacity: 40 kA

Agency Information:

Comply with DIN Dimensional standard DIN 43625, VDE 0670 part 4 and with IEC 60282-1 (2005)
 Suitable for indoor and outdoor use.

Dimensions (mm):

Fuse Reference	A	C	D	Weight (Kg)
TDLSJ	292	54	51	1.63
TFLSJ	292	80	76	3.1

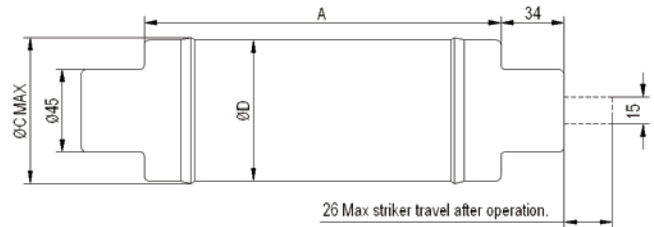

Table of ratings:

Part Number	Current Rating I_n (A)	Breaking Capacity I_1 (kA)	Minimum Breaking Capacity I_3 (A)	Cold Resistance & Watts Loss in Free Air		Joule Integral (I^2t)		Length mm	Diameter mm	Weight kg
				mΩ	W	Minimum Pre-Arcing	Maximum Operating			
7.2TDLSJ6.3	6.3	40	20	205	11	4.8×10^1	6.5×10^3	292	51	1.63
7.2TDLSJ10	10	40	31	99.7	19	2.5×10^2	2.7×10^3	292	51	1.63
7.2TDLSJ16	16	40	49	65.1	23	5.5×10^2	8.2×10^3	292	51	1.63
7.2TDLSJ20	20	40	49	48.9	27	9.7×10^2	1.1×10^4	292	51	1.63
7.2TDLSJ25	25	40	80	32.6	28	5.7×10^2	8.0×10^3	292	51	1.63
7.2TDLSJ31.5	31.5	40	100	26.0	36	8.9×10^2	1.0×10^4	292	51	1.63
7.2TDLSJ40	40	40	114	16.0	36	2.0×10^2	2.2×10^4	292	51	1.63
7.2TDLSJ50	50	40	143	12.9	46	3.2×10^2	3.2×10^4	292	51	1.63
7.2TDLSJ63	63	40	180	8.14	45	8.0×10^2	7.5×10^4	292	51	1.63
7.2TFLSJ80	80	40	264	6.01	54	5.0×10^3	6.5×10^4	292	76	3.1
7.2TFLSJ100	100	40	338	4.65	64	9.1×10^3	1.1×10^5	292	76	3.1
7.2TFLSJ125	125	40	375	3.60	79	1.5×10^4	1.7×10^5	292	76	3.1
7.2TFLSJ160	160	40	525	2.73	97	3.0×10^4	3.1×10^5	292	76	3.1

12 kV - T Range Fuse-Links

12 kV, Current Limiting Back-Up Fuse-Links, 6.3A to 200A

Specifications

Description: A range of medium voltage DIN Fuses, complete with sealed striker, suitable for transformer protection. The fuses can be used even when there is no secondary LV protection, provided they are used with fuse switches fitted with instantaneous striker tripping.

Ratings:

Volts: 6kV - 12kV
Amps: 6.3A - 200A
Breaking Capacity: 50 kA

Agency Information:

Comply with DIN Dimensional standard DIN 43625, VDE 0670 part 4, VDE 0670 part 402 and with IEC 60282-1 (2005)
Suitable for indoor and outdoor use.

Dimensions (mm):

Fuse Reference	A	C	D	Weight (Kg)
TDLEJ	292	54	51	1.7
THLEJ	292	67	64	2.6
TKLEJ	292	80	76	3.5
TXLEJ	292	88	88	3.7
TFMSJ	442	80	76	5.1



EJ Outline

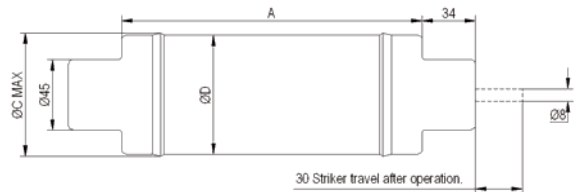

SJ Outline

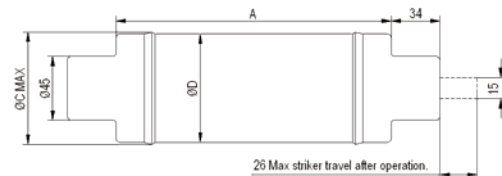

Table of ratings:

Part Number	Current Rating I_n (A)	Breaking Capacity I_1 (kA)	Minimum Breaking Capacity I_3 (A)	Cold Resistance & Watts Loss in Free Air		Joule Integral (I^2t)		Length mm	Diameter mm	Weight kg
				mΩ	W	Minimum Pre-Arcing	Maximum Operating			
12TDLEJ6.3	6.3	63	23	222	10	9.8×10^1	1.0×10^3	292	51	1.7
12TDLEJ10	10	63	35	131	16	2.8×10^2	2.3×10^3	292	51	1.7
12TDLEJ16	16	63	53	54.6	16	2.6×10^2	3.9×10^3	292	51	1.7
12TDLEJ20	20	63	73	39.1	18	5.2×10^2	5.4×10^3	292	51	1.7
12TDLEJ25	25	63	87	31.2	24	8.1×10^2	8.4×10^3	292	51	1.7
12TDLEJ31.5	31.5	63	111	23.4	28	1.4×10^3	1.5×10^4	292	51	1.7
12TDLEJ40	40	63	143	17.2	36	2.4×10^3	2.5×10^4	292	51	1.7
12TDLEJ50	50	63	168	13.5	47	2.8×10^3	3.1×10^4	292	51	1.7
12TDLEJ63	63	63	235	10.6	60	4.3×10^3	4.7×10^4	292	51	1.7
12THLEJ80	80	63	272	7.81	72	7.9×10^3	9.1×10^4	292	64	2.6
12THLEJ100	100	63	388	5.74	85	2.0×10^4	1.4×10^5	292	64	2.6
12TKLEJ125	125	63	687	3.99	93	4.0×10^4	3.5×10^5	292	76	3.5
12TXLEJ160*	160	63	560	4.30	217	1.1×10^5	5.0×10^5	292	88	3.7
12TXLEJ200*	200	63	610	3.80	333	1.5×10^5	6.5×10^5	292	88	3.7
12THMEJ100	100	63	272	5.74	85	2.0×10^4	1.4×10^5	442	64	3.7
12TFMSJ160	160	50	485	3.65	139	5.0×10^4	3.5×10^5	442	76	5.1

* Not compliant with VDE 0670 part 402

17.5 kV - T Range Fuse-Links

17.5 kV, Current Limiting Back-Up Fuse-Links, 6.3A to 125A

Specifications

Description: A range of medium voltage DIN Fuses, complete with sealed striker, suitable for transformer protection. The fuses can be used even when there is no secondary LV protection, provided they are used with fuse switches fitted with instantaneous striker tripping.

Ratings:

Volts: 10kV - 17.5kV
 Amps: 6.3A - 125A
 Breaking Capacity: 35.5kA - 50kA

Agency Information:

Comply with DIN Dimensional standard DIN 43625, VDE 0670 part 4, VDE 0670 part 402 and with IEC 60282-1 (2005)
 Suitable for indoor and outdoor use.

Dimensions (mm):

Fuse Reference	A	C	D	Weight (Kg)
TDLSJ	292	54	51	1.7
TFLSJ	292	80	76	3.1
TDMEJ	442	54	51	2.5
THMEJ	442	67	64	3.7
TKMEJ	442	80	76	5.1



EJ Outline

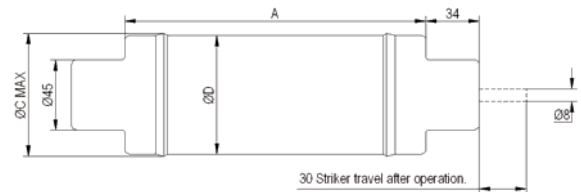

SJ Outline

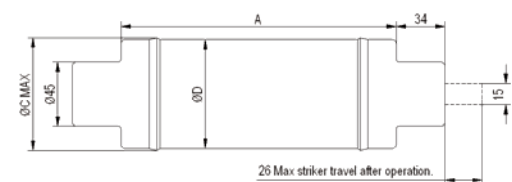

Table of ratings:

Part Number	Current Rating I_n (A)	Breaking Capacity I_1 (kA)	Minimum Breaking Capacity I_3 (A)	Cold Resistance & Watts Loss in Free Air		Joule Integral (I^2t)		Length mm	Diameter mm	Weight kg
				mΩ	W	Minimum Pre-Arcing	Maximum Operating			
17.5TDLSJ6.3*	6.3	35.5	23	313	15	4.8×10^1	6.1×10^2	292	51	1.7
17.5TDLSJ10*	10	35.5	19	185	23	2.8×10^2	4.0×10^3	292	51	1.7
17.5TDLSJ16*	16	35.5	59	104	34	2.9×10^2	2.0×10^3	292	51	1.7
17.5TDLSJ20*	20	35.5	80	69.2	38	5.7×10^2	4.4×10^3	292	51	1.7
17.5TDLSJ25*	25	35.5	100	55.4	48	8.9×10^2	6.6×10^3	292	51	1.7
17.5TDLSJ31.5*	31.5	35.5	118	41.4	58	5.1×10^2	1.1×10^4	292	51	1.7
17.5TDLSJ40*	40	35.5	148	31.1	76	8.0×10^2	1.8×10^4	292	51	1.7
17.5TFLSJ50*	50	35.5	225	17.3	62	8.1×10^3	6.0×10^4	292	76	3.1
17.5TDMEJ6.3	6.3	50	25	324	14	9.8×10^1	1.0×10^3	442	51	2.5
17.5TDMEJ10	10	50	36	192	24	2.8×10^2	2.3×10^3	442	51	2.5
17.5TDMEJ16	16	50	55	79.6	23	2.6×10^2	3.9×10^3	442	51	2.5
17.5TDMEJ20	20	50	69	57.0	27	5.2×10^2	5.4×10^3	442	51	2.5
17.5TDMEJ25	25	50	87	45.5	34	8.1×10^2	8.4×10^3	442	51	2.5
17.5TDMEJ31.5	31.5	50	87	34.1	41	1.4×10^3	1.5×10^4	442	51	2.5
17.5TDMEJ40	40	50	111	25.0	53	2.4×10^3	2.5×10^4	442	51	2.5
17.5TDMEJ50	50	50	174	19.7	69	2.8×10^3	3.1×10^4	442	51	2.5
17.5TDMEJ63	63	50	200	15.4	89	4.3×10^3	4.7×10^4	442	51	2.5
17.5THMEJ80	80	50	270	11.5	108	7.9×10^3	9.1×10^4	442	64	3.7
17.5THMEJ100	100	50	376	8.38	127	2.0×10^4	1.4×10^5	442	64	3.7
17.5TKMEJ125	125	50	467	5.95	146	3.4×10^4	3.5×10^5	442	76	5.1

* Not compliant with VDE 0670 part 402

24 kV - T Range Fuse-Links

24 kV, Current Limiting Back-Up Fuse-Links, 6.3A to 160A

Specifications

Description: A range of medium voltage DIN Fuses, complete with sealed striker, suitable for transformer protection. The fuses can be used even when there is no secondary LV protection, provided they are used with fuse switches fitted with instantaneous striker tripping.



Ratings:

Volts: 10kV - 24kV
 Amps: 6.3A - 160A
 Breaking Capacity: 50 kA - 63kA

Agency Information:

Comply with DIN Dimensional standard DIN 43625, VDE 0670 part 4, VDE 0670 part 402 and with IEC 60282-1 (2005)
 Suitable for indoor and outdoor use.

Dimensions (mm):

Fuse Reference	A	C	D	Weight (Kg)
TDMEJ	442	54	51	2.5
THMEJ	442	67	64	3.7
TFMEJ	442	80	76	5.1
TXMEJ	442	88	88	5.9

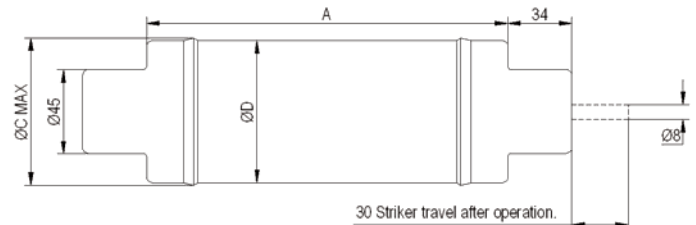

Table of ratings:

Part Number	Current Rating I_n (A)	Breaking Capacity I_1 (kA)	Minimum Breaking Capacity I_3 (A)	Cold Resistance & Watts Loss in Free Air		Joule Integral (I^2t)		Length mm	Diameter mm	Weight kg
				mΩ	W	Minimum Pre-Arcing	Maximum Operating			
24TDMEJ6.3	6.3	50	23	444	20	9.8×10^1	1.0×10^3	442	51	2.5
24TDMEJ10	10	50	34	262	32	2.8×10^2	2.3×10^3	442	51	2.5
24TDMEJ16	16	50	56	109	34	2.6×10^2	3.9×10^3	442	51	2.5
24TDMEJ20	20	50	73	78.2	38	5.2×10^2	5.4×10^3	442	51	2.5
24TDMEJ25	25	50	92	62.4	49	8.1×10^2	8.4×10^3	442	51	2.5
24TDMEJ31.5	31.5	50	92	46.8	59	1.4×10^3	1.5×10^4	442	51	2.5
24TDMEJ40	40	50	118	34.3	79	2.4×10^3	2.5×10^4	442	51	2.5
24TDMEJ50	50	50	185	27.0	98	2.8×10^3	3.1×10^4	442	51	2.5
24THMEJ63	63	50	217	21.1	127	4.3×10^3	4.7×10^4	442	64	3.7
24TFMEJ80	80	50	265	15.7	153	7.9×10^3	9.1×10^4	442	76	5.1
24TFMEJ100*	100	63	430	18.0	400	2.8×10^4	9.4×10^4	442	76	5.1
24TXMEJ125*	125	40	760	11.0	340	9.7×10^4	3.5×10^5	442	88	5.9
24TXMEJ160*	160	31.5	900	9.60	515	1.3×10^5	5.0×10^5	442	88	5.9

* Not compliant with VDE 0670 part 402

36 kV - T Range Fuse-Links

36 kV, Current Limiting Back-Up Fuse-Links, 3.15A to 63A

Specifications

Description: A range of medium voltage DIN Fuses, complete with sealed striker, suitable for transformer protection. The fuses can be used even when there is no secondary LV protection, provided they are used with fuse switches fitted with instantaneous striker tripping.

Ratings:

Volts: 17.5kV - 36kV

Amps: 3.15A - 63A

Breaking Capacity: 20kA - 35.5kA

Agency Information:

Comply with DIN Dimensional standard DIN 43625, VDE 0670 part 4,

VDE 0670 part 402 and with IEC 60282-1 (2005)

Suitable for indoor and outdoor use.

Dimensions (mm):

Fuse Reference	A	C	D	Weight (Kg)
TDQSJ	537	54	51	2.9
TFQSJ	537	80	76	6.0
TXQSJ	537	88	88	6.5
TXQEJ	537	88	88	6.5



EJ Outline

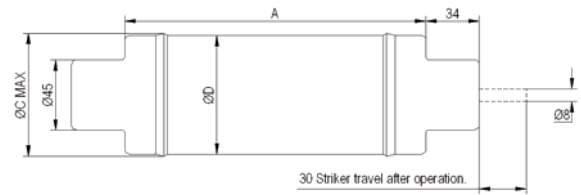

SJ Outline

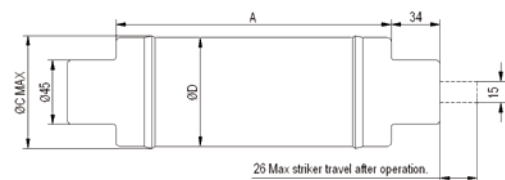

Table of ratings:

Part Number	Current Rating I_n (A)	Breaking Capacity I_1 (kA)	Minimum Breaking Capacity I_3 (A)	Cold Resistance & Watts Loss in Free Air		Joule Integral (I^2t)		Length mm	Diameter mm	Weight kg
				mΩ	W	Minimum Pre-Arcing	Maximum Operating			
36TDQSJ3.15	3.15	20	23	1455	18	2.0×10^1	2.4×10^2	537	51	2.9
36TDQSJ6.3	6.3	35.5	23	684	34	1.0×10^2	1.2×10^3	537	51	2.9
36TDQSJ10	10	35.5	35	402	44	3.1×10^2	3.6×10^3	537	51	2.9
36TDQSJ16	16	35.5	70	165	52	4.6×10^2	5.1×10^3	537	51	2.9
36TDQSJ20	20	35.5	98	117	62	8.9×10^2	8.2×10^4	537	51	2.9
36TDQSJ25	25	35.5	112	98.0	85	1.2×10^3	1.5×10^4	537	51	2.9
36TFQSJ31.5	31.5	35.5	116	73.4	96	2.1×10^3	2.3×10^4	537	51	6.0
36TFQSJ40	40	35.5	178	52.4	116	4.1×10^3	3.9×10^4	537	76	6.0
36TFQSJ50	50	35.5	255	36.8	133	8.3×10^3	8.1×10^4	537	76	6.0
36TXQEJ63*	63	20	360	35.0	271	1.1×10^4	6.2×10^4	537	88	6.5

* Not compliant with VDE 0670 part 402

Fuse-Link Bases for Mounting

12/24 kV Medium Voltage DIN Fuse Bases

Specifications

Description: A range of medium voltage DIN fuse bases. Suitable for outdoor fuse mounting, optional moving and fixed contacts, complete with or without micro-switch.

Ratings:

Volts: 12kV - 24kV
Amps: 6.3A - 200A

Agency Information:

Comply with DIN Dimensional standard DIN 43624, VDE 0670 part 4, and with IEC 60282-1 (2005)
Suitable for indoor and outdoor use.

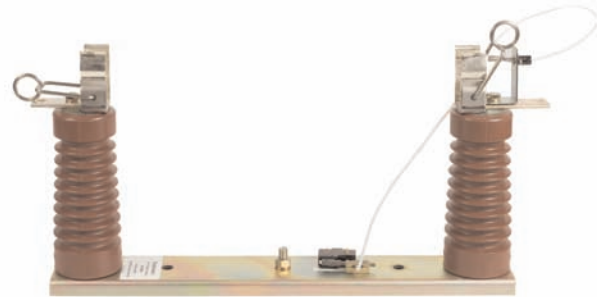

12FBMS-MC

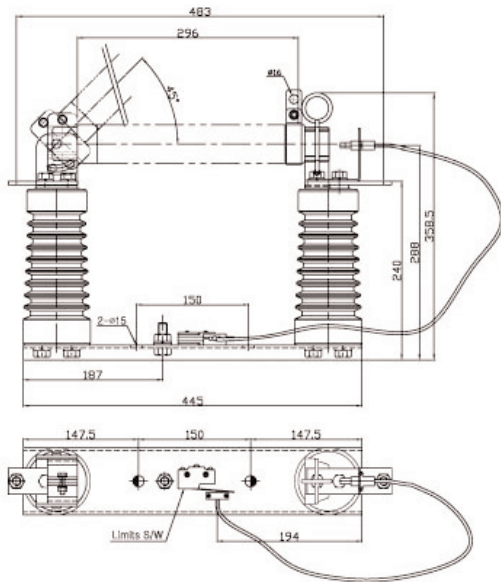

12FBMS

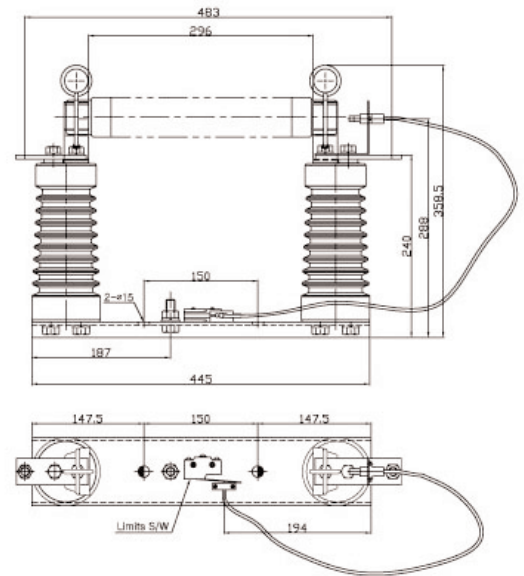

24FBMS-MC

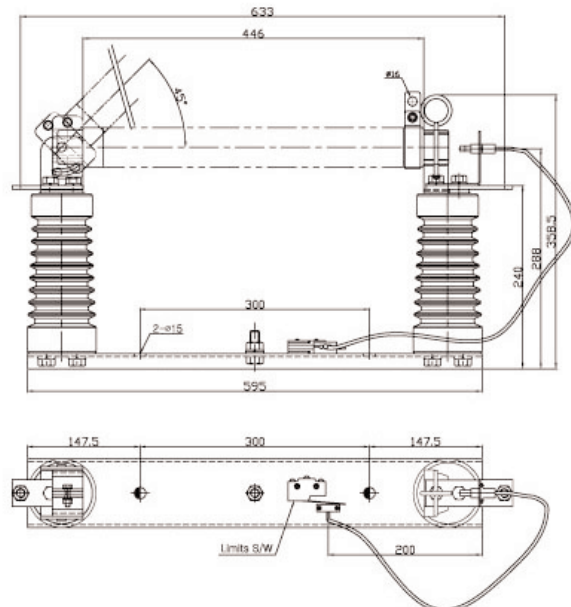

24FBMS

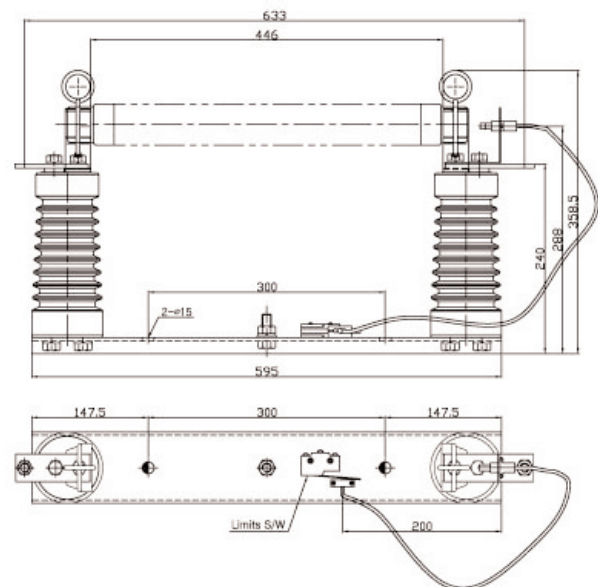

Applications

- Selection guide using LV Fuse-Links operation class gG/gL on low voltage side for individual cable exit protection.

Transformer Rating (kVA)	Transformer Primary Voltage					
	10 (kV)		20 (kV)		30 (kV)	
	Rated Current of the Medium Voltage Fuse-Link		Rated Current of the Medium Voltage Fuse-Link		Rated Current of the Medium Voltage Fuse-Link	
	Min	Max	Min	Max	Min	Max
50	6.3	10	6.3	6.3	3.15	3.15
100	16	25	6.3	10	6.3	10
125	16	25	10	16	6.3	10
160	20	31.5	10	20	6.3	10
200	20	40	16	25	10	16
250	25	50	16	25	10	16
315	31.5	63	20	31.5	16	16
400	40	80	20	40	16	25
500	50	100	25	50	16	31.5
630	63	125	31.5	63	20	40
800	80	125	40	63	25	40
1000	100	125	50	80	31.5	50
1250	125	200	63	80	40	50
1600	160	200	71	125	50	63
2000	200	200	100	160	63	63

- Selection guide using LV Fuse-Links operation class gG/gL on low voltage side for overload protection of the transformer.

Transformer Rating (kVA)	Transformer Primary Voltage						Low Voltage NH Fuse Size gG/gL (A)
	10 (kV)		20 (kV)		30 (kV)		
	Rated Current of the Medium Voltage Fuse-Link		Rated Current of the Medium Voltage Fuse-Link		Rated Current of the Medium Voltage Fuse-Link		
	Min	Max	Min	Max	Min	Max	
50	10	10	6.3	6.3	3.15	3.15	63
100	16	25	10	10	6.3	10	125
125	20	25	10	16	6.3	10	160
160	25	31.5	16	20	10	10	200
200	31.5	40	16	25	16	16	250
250	40	50	20	25	16	16	315
315	50	63	25	31.5	16	20	400
400	63	80	31.5	40	20	25	500
500	80	100	40	50	25	31.5	630
630	100	125	63	63	31.5	40	800
800	125	160	63	63	40	40	1000
1000	200	200	80	80	50	50	1250

Applications

- Selection guide according to DIN VDE 0670 part 402 using LV fuse-links operating class gTr on low voltage side for overload protection of the transformer.

Transformer Rating	Transformer Primary Voltage						Low Voltage NH Fuse Size gTr (A)
	10 (kV)		20 (kV)		30 (kV)		
	Rated Current of the Medium Voltage Fuse-Link		Rated Current of the Medium Voltage Fuse-Link		Rated Current of the Medium Voltage Fuse-Link		
(kVA)	Min	Max	Min	Max	Min	Max	
100	16	16	10	10	6.3	6.3	100
125	16	16	10	10	10	10	125
160	20	25	16	16	10	10	160
200	25	31.5	16	16	16	16	200
250	31.5	40	16	25	16	20	250
315	40	50	25	25	20	25	315
400	50	63	25	31.5	25	25	400
500	63	80	31.5	40	25	31.5	500
630	80	100	40	50	31.5	40	630
800	100	125	63	63	40	50	800
1000	125	160*	63	80	40	50	1000

* Not compliant with VDE 0670 part 402

- Selection of these MV Fuse-Links has been based on the following:

- 1 - The fuse-link should withstand transformer magnetising inrush currents, taken as 12 times full load current for 0.1 seconds.
- 2 - The fuse-link should discriminate with the rating of the secondary fuse-link stated or where only individual cable exit protection exists, the highest rating likely to be used.
- 3 - The fuse-link should operate within 2 seconds for transformers complying with IEC 60076-5 in respect of impedance, voltage and short circuit withstand current.
- 4 - The fuse-link should operate reasonably quickly in the event of a transformer internal fault or an earth fault in the secondary terminal zone of the transformer.
- 5 - In the case where there is no secondary fuse-link for overload protection, the minimum recommended HV fuse-link rating applies to the use of fuse-links in encapsulated enclosures where permissible continuous overload is generally limited to 120% of transformer full load current. However, if greater overload currents are permissible a higher rating of fuse-link may be required. Where the fuse-link is used in open air or conditions of unrestricted ventilation a higher permissible overload may be possible.
- 6 - In most cases more than one rating of HV fuse-link is recommended for a particular transformer size. Choice of fuse-link will then depend on which fuse-link offers the best protection e.g. having one fuse-link for several transformer sizes.

Recommendations for other voltage are available on request.

Medium Voltage DIN Fuses

Cross-Reference

COOPER BUSSMANN	EFEN	SIBA	MESA	ETI (80N striker)	ETI (50N striker)	Merlin Gerin	ELIMSAN	INAEI (type)	ABB
3.6ADOSJ6.3	67110.0060	3000213	CF-7,2/6.3	4226005	4225005	51006 500 MO	N/A	IB-D2	1YMB531001M0001
3.6ADOSJ10	67110.00100	3000213	CF-7,2/10	4226006	4225006	51007 501 MO	N/A	IB-D2	1YMB531001M0002
3.6ADOSJ16	67110.0160	3000213	CF-7,2/16	4226007	4225007	51008 502 MO	N/A	IB-D2	1YMB531001M0003
3.6ADOSJ20	67110.0200	3000213	CF-7,2/20	4226008	4225008	51009 503 MO	N/A	IB-D2	N/A
3.6ADOSJ25	67110.0250	3000213	CF-7,2/25	4226009	4225009	51010 504 MO	N/A	IB-D2	1YMB531001M0004
3.6ADOSJ31.5	67110.0320	3000213	CF-7,2/31.5	4226010	4225010	51011 505 MO	N/A	IB-D2	N/A
3.6ADOSJ40	67110.0400	3000213	CF-7,2/40	4226011	4225011	51012 506 MO	N/A	IB-D2	1YMB531001M0005
3.6WDOSJ50	67110.0500	3000213	CF-7,2/50	4226012	4225012	51013 507 MO	N/A	IB-D2	1YMB531001M0006
3.6WDOSJ63	67110.0630	3001013	CF-7,2/63	4226013	4225013	51014 508 MO	N/A	IB-D2	1YMB531001M0007
3.6WDOSJ80	67110.0800	3001013	CF-7,2/80	4226014	4225014	51015 509 MO	N/A	IB-D2	1YMB531001M0008
3.6WDOSJ100	67110.1000	3001013	CF-7,2/100	4226015	4225015	51016 510 MO	N/A	IB-D2	1YMB531001M0009
3.6WDOSJ125	67110.1250	3001013	N/A	4226016	4225016	N/A	N/A	N/A	N/A
3.6WFOSJ160	67110.1600	3001813	N/A	4226017	4225017	N/A	N/A	N/A	N/A
3.6WFOSJ200	67210.2000	3001814	N/A	N/A	N/A	N/A	N/A	N/A	N/A
7.2TDLJ6.3	N/A	3009813	N/A	N/A	N/A	N/A	N/A	N/A	1YMB531034M0001
7.2TDLJ10	N/A	3009813	N/A	N/A	N/A	N/A	N/A	N/A	1YMB531034M0002
7.2TDLJ16	N/A	3009813	N/A	N/A	N/A	N/A	N/A	N/A	1YMB531034M0003
7.2TDLJ20	N/A	3009813	N/A	N/A	N/A	N/A	N/A	N/A	N/A
7.2TDLJ25	N/A	3009813	N/A	N/A	N/A	N/A	N/A	N/A	1YMB531034M0004
7.2TDLJ31.5	N/A	3009813	N/A	N/A	N/A	N/A	N/A	N/A	N/A
7.2TDLJ40	N/A	3009813	N/A	N/A	N/A	N/A	N/A	N/A	1YMB531034M0005
7.2TDLJ50	N/A	3009813	N/A	N/A	N/A	N/A	N/A	N/A	1YMB531034M0006
7.2TDLJ63	N/A	3009913	N/A	N/A	N/A	N/A	N/A	N/A	1YMB531034M0007
7.2TFLSJ80	N/A	3009913	N/A	N/A	N/A	N/A	N/A	N/A	1YMB531034M0008
7.2TFLSJ100	N/A	3009913	N/A	N/A	N/A	N/A	N/A	N/A	1YMB531034M0009
7.2TFLSJ125	N/A	3009913	CF-7,2/125	N/A	N/A	757352 BN	N/A	N/A	1YMB531034M0010
7.2TFLSJ160	N/A	3010013	CF-7,2/160	N/A	N/A	757352 BP	N/A	N/A	1YMB531034M0011
12TDLEJ6.3	67120.0060	3000413	CF-12/6.3	4236005	4235005	51006 511 MO	ES 6509 006	IB-D1	1YMB531042M0001
12TDLEJ10	67120.0100	3000413	CF-12/10	4236006	4235006	51006 512 MO	ES 6509 010	IB-D1	1YMB531042M0002
12TDLEJ16	67120.0160	3000413	CF-12/16	4236007	4235007	51006 513 MO	ES 6509 016	IB-D1	1YMB531042M0003
12TDLEJ20	67120.0200	3000413	CF-12/20	4236008	4235008	51006 514 MO	ES 6509 020	IB-D1	1YMB531042M0004
12TDLEJ25	67120.0250	3000413	CF-12/25	4236009	4235009	51006 515 MO	ES 6509 025	IB-D1 & IB-D2	1YMB531042M0005
12TDLEJ31.5	67120.0320	3000413	CF-12/31.5	4236010	4235010	51006 516 MO	ES 6509 030	IB-D1 & IB-D2	1YMB531042M0006
12TDLEJ40	67120.0400	3000413	CF-12/40	4236011	4235011	51006 517 MO	ES 6509 040	IB-D1 & IB-D2	1YMB531042M0007
12TDLEJ50	67120.0500	3000413	CF-12/50	4236012	4235012	51006 518 MO	ES 6509 050	IB-D2	1YMB531042M0008
12TDLEJ63	67120.0630	3001213	CF-12/63	4236013	4235013	51006 519 MO	ES 6509 063	IB-D2	1YMB531042M0009
12THLEJ80	67120.0800	3001213	CF-12/80	4236014	4235014	51006 520 MO	ES 6509 080	IB-D3	1YMB531042M0021
12THLEJ100	67120.1000	3001213	CF-12/100	4236015	4235015	51006 521 MO	ES 6509 100	IB-D3	1YMB531042M0022
12TKLEJ125	67120.1250	3001213	N/A	4236016	4235016	N/A	N/A	N/A	1YMB531043M0010
12TXLEJ160	67220.1600	3002013	N/A	4236017	4235017	N/A	N/A	N/A	N/A
12TXLEJ200	67220.2000	3002014	N/A	N/A	N/A	N/A	N/A	N/A	N/A
17.5TDLJ6.3	N/A	3025513	N/A	N/A	N/A	N/A	N/A	IB-D1	1YMB531003M0001
17.5TDLJ10	N/A	3025513	CFR-17,5/10	N/A	N/A	51006 522 MO	N/A	IB-D1	1YMB531003M0002
17.5TDLJ16	N/A	3025513	CFR-17,5/16	N/A	N/A	51006 523 MO	N/A	IB-D1	1YMB531003M0003
17.5TDLJ20	N/A	3022113	N/A	N/A	N/A	N/A	N/A	IB-D1	1YMB531003M0013
17.5TDLJ25	N/A	3022113	CFR-17,5/25	N/A	N/A	51006 524 MO	N/A	IB-D1 & IB-D2	1YMB531003M0004
17.5TDLJ31.5	N/A	3022113	CFR-17,5/31.5	N/A	N/A	51006 525 MO	N/A	IB-D1 & IB-D2	1YMB531003M0014
17.5TDLJ40	N/A	3022113	CFR-17,5/40	N/A	N/A	51006 526 MO	N/A	IB-D1 & IB-D2	1YMB531003M0021
17.5TFLSJ50	N/A	3022113	N/A	N/A	N/A	N/A	N/A	IB-D2	1YMB531003M0022
17.5TDMEJ6.3	N/A	3023113	N/A	N/A	N/A	N/A	N/A	IB-D1	1YMB531037M0001
17.5TDMEJ10	N/A	3023113	N/A	N/A	N/A	N/A	N/A	IB-D1	1YMB531037M0002
17.5TDMEJ16	N/A	3023113	N/A	N/A	N/A	N/A	N/A	IB-D1	1YMB531037M0003
17.5TDMEJ20	N/A	3023113	N/A	N/A	N/A	N/A	N/A	IB-D1	1YMB531037M0013
17.5TDMEJ25	N/A	3023113	N/A	N/A	N/A	N/A	N/A	IB-D1	1YMB531037M0004
17.5TDMEJ31.5	N/A	3023113	N/A	N/A	N/A	N/A	N/A	IB-D1	1YMB531037M0014
17.5TDMEJ40	N/A	3023113	N/A	N/A	N/A	N/A	N/A	IB-D1	1YMB531037M0021
17.5TDMEJ50	N/A	3023213	N/A	N/A	N/A	N/A	N/A	N/A	1YMB531037M0006
17.5TDMEJ63	N/A	3023213	N/A	N/A	N/A	N/A	N/A	IB-D2	1YMB531037M0007
17.5THMEJ80	N/A	3023213	N/A	N/A	N/A	N/A	N/A	N/A	1YMB531037M0008
17.5THMEJ100	N/A	3023313	N/A	N/A	N/A	N/A	N/A	IB-D2	1YMB531003M0009
17.5TKMEJ125	N/A	3023314	N/A	N/A	N/A	N/A	N/A	N/A	1YMB531003M0010
24TDMEJ6.3	67140.0060	3000613	CF-24/6.3	4256005	4255005	51006 538 MO	ES 6513-006	IB-D1	1YMB531044M0001
24TDMEJ10	67140.0100	3000613	CF-24/10	4256006	4255006	51006 539 MO	ES 6513-010	IB-D1	1YMB531044M0002
24TDMEJ16	67140.0160	3000613	CF-24/16	4256007	4255007	51006 540 MO	ES 6513-016	IB-D1	1YMB531044M0003
24TDMEJ20	67140.0200	3000613	CF-24/20	4256008	4255008	51006 541 MO	ES 6513-020	IB-D1	1YMB531044M0004
24TDMEJ25	67140.0250	3000613	CF-24/25	4256009	4255009	51006 542 MO	ES 6513-025	IB-D1 & IB-D2	1YMB531044M0005
24TDMEJ31.5	67140.0320	3000613	CF-24/31.5	4256010	4255010	51006 543 MO	ES 6513-030	IB-D1 & IB-D2	1YMB531044M0012
24TDMEJ40	67140.0400	3000613	CF-24/40	4256011	4255011	51006 544 MO	ES 6513-040	IB-D1 & IB-D2	1YMB531044M0005
24TDMEJ50	67140.0500	3001413	CF-24/50	4253012	4255012	51006 545 MO	ES 6513-050	IB-D2	1YMB531004M0021
24THMEJ63	67140.0630	3001413	CF-24/63	4253013	4255013	51006 546 MO	ES 6513-063	IB-D2	1YMB531004M0022
24TFMEJ80	67140.0800	3001413	CF-24/80	4253014	4255014	51006 547 MO	ES 6513-080	IB-D3	1YMB531022M0001
24TFMEJ100	67240.1000	3002213	CF-24/100	4253015	4255015	51006 548 MO	ES 6513-100	IB-D3	1YMB531022M0002
24TXMEJ125	67240.1250	3002213	N/A	4253016	4255016	N/A	N/A	N/A	1YMB531022M0003
24TXMEJ160	67240.1600	N/A	N/A	N/A	N/A	N/A	N/A	N/A	N/A
36TDQSJ3.15	N/A	N/A	N/A	N/A	N/A	N/A	N/A	N/A	N/A
36TDQSJ6.3	67150.0060	3000813	CF-36/6.3	4266005	4265005	51006 549 MO	ES 6515-006	IB-D1	1YMB531006M0001
36TDQSJ10	67150.0100	3000813	CF-36/10	4266006	4265006	51006 550 MO	ES 6515-010	IB-D1	1YMB531006M0002
36TDQSJ16	67150.0160	3000813	CF-36/16	4266007	4265007	51006 551 MO	ES 6515-016	IB-D1	1YMB531006M0003
36TDQSJ20	67150.0200	3000813	CF-36/20	4266008	4265008	51006 552 MO	ES 6515-020	IB-D1 & IB-D2	N/A
36TDQSJ25	67150.0250	3000813	CF-36/25	4266009	4265009	51006 553 MO	ES 6515-025	IB-D1 & IB-D2	1YMB531006M0004
36TFQSJ31.5	67150.0320	3001613	CF-36/31.5	4266010	4265010	51006 554 MO	ES 6515-030	IB-D2	N/A
36TFQSJ40	67150.0400	3001613	CF-36/40	4266011	4265011	51006 555 MO	ES 6515-040	IB-D2	1YMB531006M0005
36TFQSJ50	67150.0500	3002413	CF-36/50	4266012	4265012	51006 556 MO	ES 6515-050	IB-D3	N/A
36TXQEJ63	67150.0630	3002413	CF-36/63	4266013	4265013	51006 557 MO	ES 6515-063	IB-D3	N/A

Striker Force Diagrams

E = Spring Striker 80N to DIN IEC 60282-1 designation “medium”

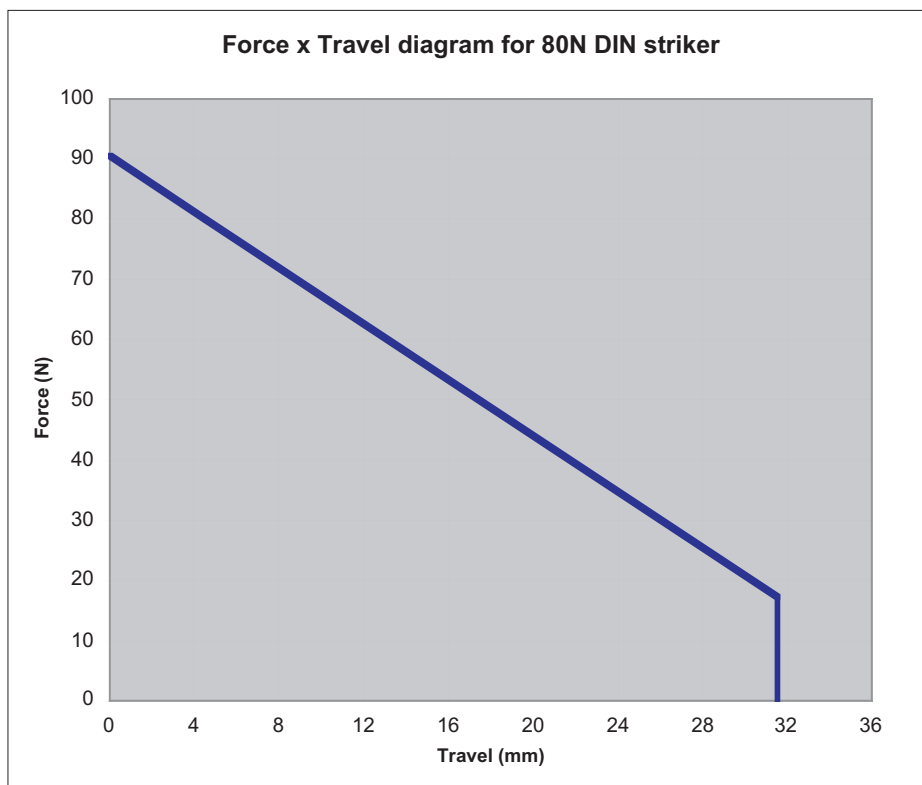

S = Spring Striker 50N to DIN 43625 and IEC 60282-1 designation “medium”

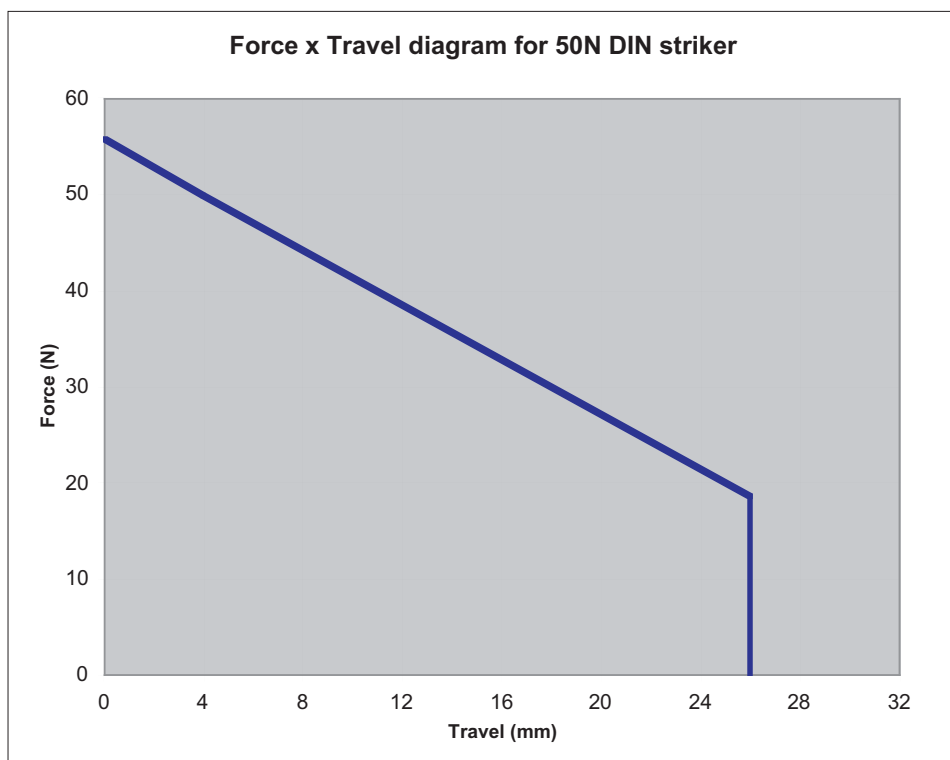

Part Referencing System for Current Limiting Fuses

kV	1 st Letter General Type	2nd Letter Barrel Diameter (mm)	3rd Letter Barrel Length (mm)	4th Letter Striker	5th/6th Letter and/or Digit - Termination or Fixing	Amps A
	T = DIN Indoor/Outdoor range W,A = DIN Indoor Range	D = 50.8 H = 63.5 F, K = 76.2 X = 88	O = 192 L = 292 M = 442 Q = 537	S = Striker to DIN 43625, form C, 50N E = Striker to DIN 43625, 80N	J = Ferrule to DIN 43625	

This reference number should be quoted in all correspondence. For example, when ordering or progressing an order or when making a technical enquiry.

Ordering Key

Symbol							Meaning
1	2	3	4	5	6	7	
X							Rated voltage of the fuse-link in kV
	X						The type of fuse-link given by a single letter
		X					Diameter of the fuse-link barrel (in mm) denoted by a letter
			X				Length of the fuse-link barrel (in mm) denoted by a letter
				X			Striker information: type of striker (if fitted) is denoted by a letter *
					X		Tag information: type, if fitted, denoted by a letter
						X	Current rating of the fuse-link given in amperes

1 > Voltage

4 > Barrel length

S = Spring striker 50N

2 > Type designation letter

5 > Striker information*

E = Spring striker 80N

3 > Barrel diameter

6 > Tag information

N = No striker fitted

Ordering Code Information	Type Designation						
Rated Voltage of the Fuse-Link	12						
Type of Fuse-Link		T					
Body Diameter			D				
Body Length				L			
Type of Striker					E		
Type of Tag						J	
Current Rating							50
Complete Part Number	12	T	D	L	E	J	50

Part number **12TDLEJ50** represents an outdoor DIN fuse rated at **12kV** for use in **Air (T)** with a body diameter of **50.8mm (D)**, a barrel length of **292mm (L)**, a striker to **DIN 43625 80N (E)**, a tag arrangement to **DIN 43625 (J)** and an Amp rating of **50A**.

Cooper Bussmann Products And Technical Expertise Delivered Worldwide

Customer Assistance

Customer Satisfaction Team

The Cooper Bussmann® Customer Satisfaction Team is available to answer questions regarding Cooper Bussmann® products and services.

Contact can be made between

Monday - Thursday 7:30 a.m. - 5:30 p.m. GMT
Friday 7:30 a.m. - 5.00 p.m. GMT

The Customer Satisfaction Team can be reached via:

- Phone: 00 44 (0) 1509 882 600
- Fax: 00 44 (0) 1509 882 786
- E-mail: sales@cooperbussmann.co.uk

Application Engineering

Application Engineering assistance is available to all customers. The Application Engineering team is staffed by university qualified electrical engineers and available by phone with technical and application support.

Contact can be made between

Monday - Thursday 7.30 a.m. - 5.30 p.m. GMT
Friday 7.30 a.m. - 5.00 p.m. GMT

Application Engineering can be reached via:

- Phone: 00 44 (0) 1509 882 699
- Fax: 00 44 (0) 1509 882 794
- E-mail: technical@cooperbussmann.co.uk

Web Services

www.cooperbussmann.com

The Cooper Bussmann® website makes available free information and other resources that include:

- Product Data Sheets for complete technical information on Cooper Bussmann® products
- Online catalogue for the latest United States and European catalogues
- Safety BASICS™ for the essentials of electrical safety
- Training Modules for increasing skill levels of customers and end users
- Fuse Cross Reference to find the correct Bussmann replacement for a competitive fuse
- Arc-Flash calculator to determine the incident energy level and flash protection boundary along with the recommendations the level of Personal Protective Equipment (PPE)

Your Authorised Cooper Bussmann Distributor is:



COOPER Lighting



COOPER Crouse-Hinds



COOPER Power Systems



COOPER Wiring Devices



COOPER B-Line



Cooper Bussmann (UK) Ltd • Melton Road, Burton-on-the-Wolds, Leicestershire,
LE12 5TH UK •

Tel: 44 (0)1509 882 737 • Fax: 44 (0)1509 882 786
Email: sales@cooperbussmann.co.uk • www.cooperbussmann.com



Reorder # MVDIN-2008